



Project: \_\_\_\_\_  
Customer: \_\_\_\_\_  
Engineer: \_\_\_\_\_  
Pump Manufacturer: \_\_\_\_\_

## Technical Data Submittal Document

### Model JP3 Across the Line Start Jockey Pump Controller



#### Contents:

- Data Sheets
- Dimensional Data
- Wiring Schematics
- Field Connections

Note: The drawings included in this package are for controllers covered under our standard offering.  
Actual AS BUILT drawings may differ from what is shown in this package.

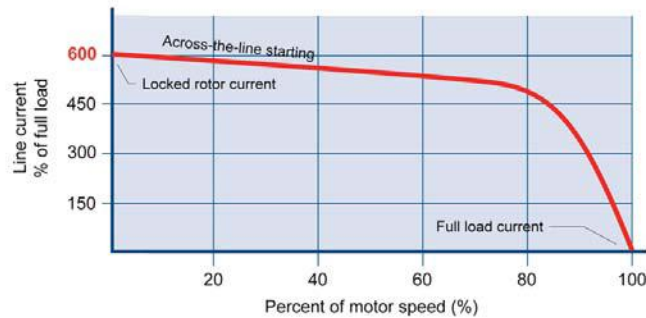
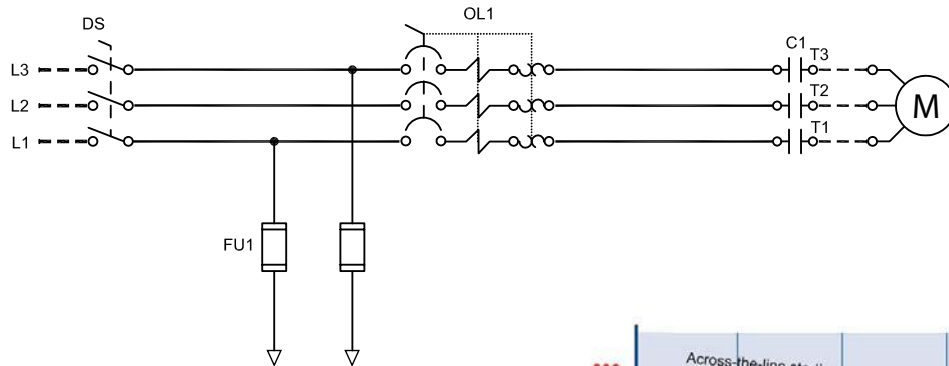

**Starting Method:** Full Voltage  
 Across the line (Direct on line)  
**Typical Voltage Applied at Start:** 100%  
**Inrush Current:** 6 x normal load current  
**Starting Torque:** 100%  
**Motor Type:** Across the line (Direct on line)  
**No. of Contactors:** 1 at 100% of horsepower  
**Min. ampacity of motor conductors:** 3 at 125% x 100% of Full load Current (FLC)

<b>Listing</b>	Underwriters Laboratory (UL)	UL508A - Industrial Pump Controllers
	CSA	CSA C22.2 No. 14 Industrial Control Equipment
	New York City	Accepted for use in the City of New York by the Department of Buildings
	<b>Optional</b>	
	<input type="checkbox"/> CE Mark	Various EN, IEC & CEE directives and standards
<b>Enclosure</b>	<b>Protection Rating</b>	
	<input type="checkbox"/> Standard: NEMA 2 (IP31)	
	<b>Optional</b>	
	<input type="checkbox"/> NEMA 12	<input type="checkbox"/> NEMA 4X-304 sst painted
	<input type="checkbox"/> NEMA 3	<input type="checkbox"/> NEMA 4X-304 sst brushed finish
	<input type="checkbox"/> NEMA 3R	<input type="checkbox"/> NEMA 4X-316 sst painted
	<input type="checkbox"/> NEMA 4	<input type="checkbox"/> NEMA 4X-316 sst brushed finish
	<b>Accessories</b>	<b>Paint Specifications</b>
	• Wall mounting lugs ( x4)	• Red RAL3002 • Powder coating • Glossy textured finish



# Technical Data

## Model JP3 Jockey Pump Controller

<b>Fuseless Motor Starter</b>	<ul style="list-style-type: none"> <li>• Main disconnect – rotary type - door interlocked</li> <li>• Thermo-magnetic motor protector</li> <li>• Contactor</li> </ul>		
<b>Control Circuit</b>	<ul style="list-style-type: none"> <li>• 24V.AC</li> </ul>		
<b>iPD+ Operator Interface</b>	<ul style="list-style-type: none"> <li>• Solid state controls</li> <li>• All adjustments on door front</li> <li>• Navigation pushbuttons</li> </ul>		
<b>Pressure Sensing</b>	<ul style="list-style-type: none"> <li>• Pressure transducer for fresh water application 316 stainless steel construction</li> <li>• Rated for 0-600psi working pressure</li> <li>• Pressure sensing line connection 1/4" Male NPT</li> </ul>		
<b>Visual Indications</b>	<ul style="list-style-type: none"> <li>• Manual motor start/run LED</li> <li>• Automatic motor start/run LED</li> <li>• Motor overload</li> <li>• Pressure reading               <ul style="list-style-type: none"> <li>• Start pressure</li> <li>• Stop pressure</li> <li>• System pressure</li> </ul> </li> <li>• System pressure diagnostic LED's               <ul style="list-style-type: none"> <li>• Green: system pressure at or above stop pressure</li> <li>• Yellow: system pressure between start and stop pressure</li> <li>• Red: system pressure at or below start pressure</li> </ul> </li> <li>• AUTO mode</li> <li>• OFF mode</li> </ul>		
<b>Timers</b>	<ul style="list-style-type: none"> <li>• Minimum run timer (off delay)</li> <li>• Delay start timer (on delay)</li> <li>• Visual countdown</li> </ul>		
<b>Counters</b>	<ul style="list-style-type: none"> <li>• Pump start counter</li> <li>• Elapsed timer meter (hours / non-resettable)</li> </ul>		
<b>Operators</b>	<ul style="list-style-type: none"> <li>• OFF-AUTO pushbutton</li> <li>• Start and Stop pushbutton</li> </ul>		
<b>Operation</b>	Automatic Start	Start on pressure drop	
	Manual Start	Start pushbutton	
	Stopping	Stop pushbutton	
	Timers	Field adjustable & visual countdown	<ul style="list-style-type: none"> <li>• Minimum run timer (off delay)</li> <li>• Delay start timer (on delay)</li> </ul>



# Technical Data Model JP3 Jockey Pump Controller

<input type="checkbox"/> A5	Motor run alarm contact
<input type="checkbox"/> A6	Loss of power alarm contact
<input type="checkbox"/> A7	Overload or short circuit alarm contact
<input type="checkbox"/> D12	CE Mark c/w externally mounted wetted parts
<input type="checkbox"/> D13A	Externally mounted wetted parts
<input type="checkbox"/> D14	Export packing for 1 controller
<input type="checkbox"/> D18	Audible alarm
<input type="checkbox"/> D19	Anti-condensation heater and thermostat
<input type="checkbox"/> D20	Anti-condensation heater and humidistat
<input type="checkbox"/> D21	Tropicalization
<input type="checkbox"/> D22	Phase reversal / failure pilot light and alarm contact
<input type="checkbox"/> D23	Controller power healthy pilot light and alarm contact
<input type="checkbox"/> D24	Pump failure via current sensing relay with pilot light and dry alarm contact
<input type="checkbox"/> D25	Low zone pump control function
<input type="checkbox"/> D26	Mid zone pump control function
<input type="checkbox"/> D27	High zone pump control function
<input type="checkbox"/> D28	Selector switch in auto alarm contacts
<input type="checkbox"/> D29	Selector switch in off alarm contacts
<input type="checkbox"/> D30	Motor heater circuit
<input type="checkbox"/> D32	Service entrance rated - 100kA short circuit withstand rating: • 120V/1ph (0.5hp max.) • 240V/1ph (1hp max.) • 200V-208V - 60hz (2hp max.) • 220V-240V - 60hz (3hp max.) • 380V-416V - 50hz - 60hz (5hp max.) • 440V-480V - 60hz (5hp max.)
<input type="checkbox"/> D33	Service entrance rated - 65kA short circuit withstand rating: • 120V/1ph (0.5hp max.) • 240V/1ph (1hp max.) • 200V-208V - 60hz (3hp-15hp max.) • 220V-240V - 60hz (5-15hp max.) • 380V-416V - 50hz - 60hz (7.5hp - 40hp max.) • 440V-480V - 60hz (7.5hp-40hp max.)
<input type="checkbox"/> D34	Service entrance rated - 42kA short circuit withstand rating: • 600V - 60hz (7.5hp max.)

<input type="checkbox"/> L01	Other language and English (bilingual)
<input type="checkbox"/> L02	French
<input type="checkbox"/> L03	Spanish
<input type="checkbox"/> L04	German
<input type="checkbox"/> L05	Italian
<input type="checkbox"/> L06	Polish
<input type="checkbox"/> L07	Romanian
<input type="checkbox"/> L08	Hungarian
<input type="checkbox"/> L09	Slovak
<input type="checkbox"/> L10	Croatian
<input type="checkbox"/> L11	Czech
<input type="checkbox"/> L12	Portuguese
<input type="checkbox"/> L13	Dutch
<input type="checkbox"/> L14	Russian
<input type="checkbox"/> L15	Turkish
<input type="checkbox"/> L16	Swedish
<input type="checkbox"/> L17	Bulgarian
<input type="checkbox"/> L18	Thai
<input type="checkbox"/> L19	Indonesian
<input type="checkbox"/> L20	Slovenian

Note: Options chosen from this page are not electrically represented on the wiring schematics in this submittal package.

*iPD+* Operator Interface

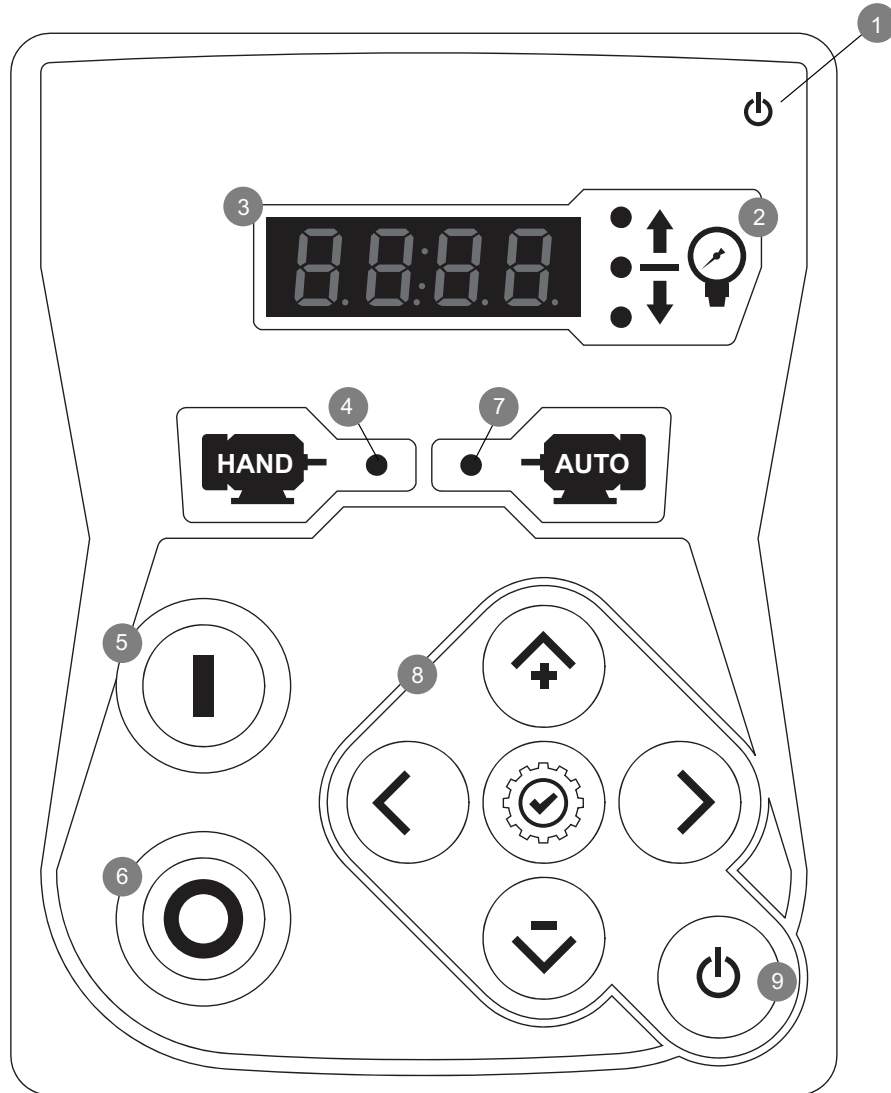

- |                       |                         |
|-----------------------|-------------------------|
| 1 - Power on LED      | 6 - STOP pushbutton     |
| 2 - System status LED | 7 - Auto start LED      |
| 3 - Digital display   | 8 - Navigation keypad   |
| 4 - Hand start LED    | 9 - ON - OFF pushbutton |
| 5 - START pushbutton  |                         |

# Jockey Pump Controller

Across the Line / 3 Phase

## Model:JP3

PER QUOTE DRAWING No.



NYC  
Dept of Building  
Approved



REV.	DESCRIPTION	DD/MM/YY	Drawing No.
0	First Issue	04/07/14	
1	Dimension Table and Notes	17/10/14	
2	IPD+ R221B	23/01/14	

Dimension

Built to the latest edition of the UL 508A & CSA C22.2 No.14

JP3-DI500 /E

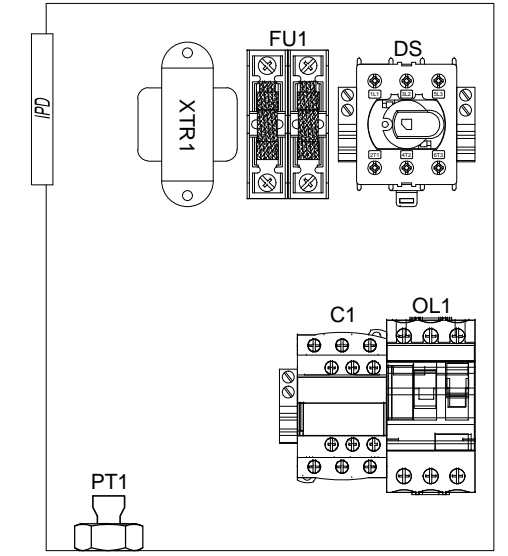
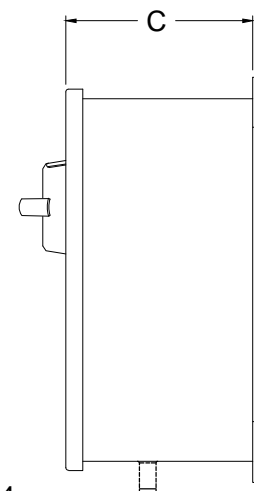
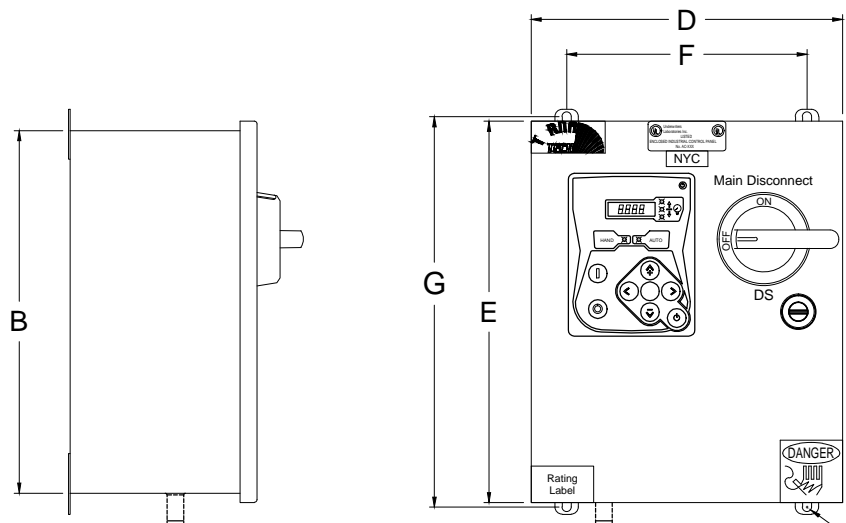

Standard Internal Layout

Ø 3/8" [9] x4

Sensing Line Connection 1/4" M.NPT

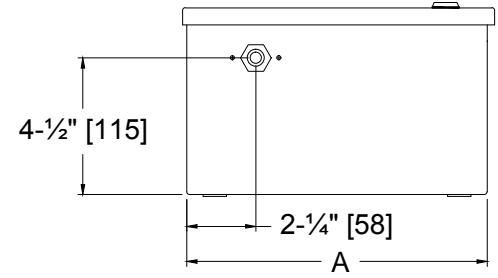

Maximum Motor Horsepower					Dimension*		
200-208V	220-240V	380-416V	440-480V	575-600V	Dimension Enclosure A X B X C	Dimension Door D X E	Dimension Anchor F X G
3HP	3HP	7.5HP	7.5HP	10HP	10"X12"X6-1/2"	10-5/8"X12-5/8"	8"X12-3/4"
5HP	5HP	10HP	10HP	15HP	10"X12"X6-1/2"	10-5/8"X12-5/8"	8"X12-3/4"
10HP	10HP	20HP	20HP	25HP	10"X12"X6-1/2"	10-5/8"X12-5/8"	8"X12-3/4"
20HP	20HP	40HP	50HP	50HP	16"X16"X7-1/2"	16-1/2"X16-1/2"	14"X16-3/4"
25HP	30HP	50HP	60HP	60HP	TBD	TBD	TBD

- Notes:
- Standard NEMA: NEMA 2
  - Standard Paint : Textured Red RAL 3002.
  - All Dimensions are in Inches [Millimeters]
  - Use Watertight Conduit and Connector Only.
  - Protect Equipment Against Drilling Chips.
  - Door Swing Equal to Door Width

- Drawing for information only.  
 Manufacturer reserves the right to modify this drawing without notice.  
 Contact manufacturer for "As Built" drawing.  
 \*-Dimension may change depending on option required. Consult Factory for exact dimensions.

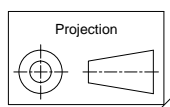

# Jockey Pump Controller

Across the Line / 3 Phase

## Model:JP3

### Wiring schematic

Built to the latest edition of the UL 508A & CSA C22.2 No.14

PER QUOTE DRAWING No.



NYC  
Dept of Building  
Approved



REV.	DESCRIPTION	DD/MM/YY
0	First Issue	04/07/14
1	Remove Dimension Table	17/10/14
2	IPD+ R221B	23/01/14

Drawing No. JP3-WS500 /E

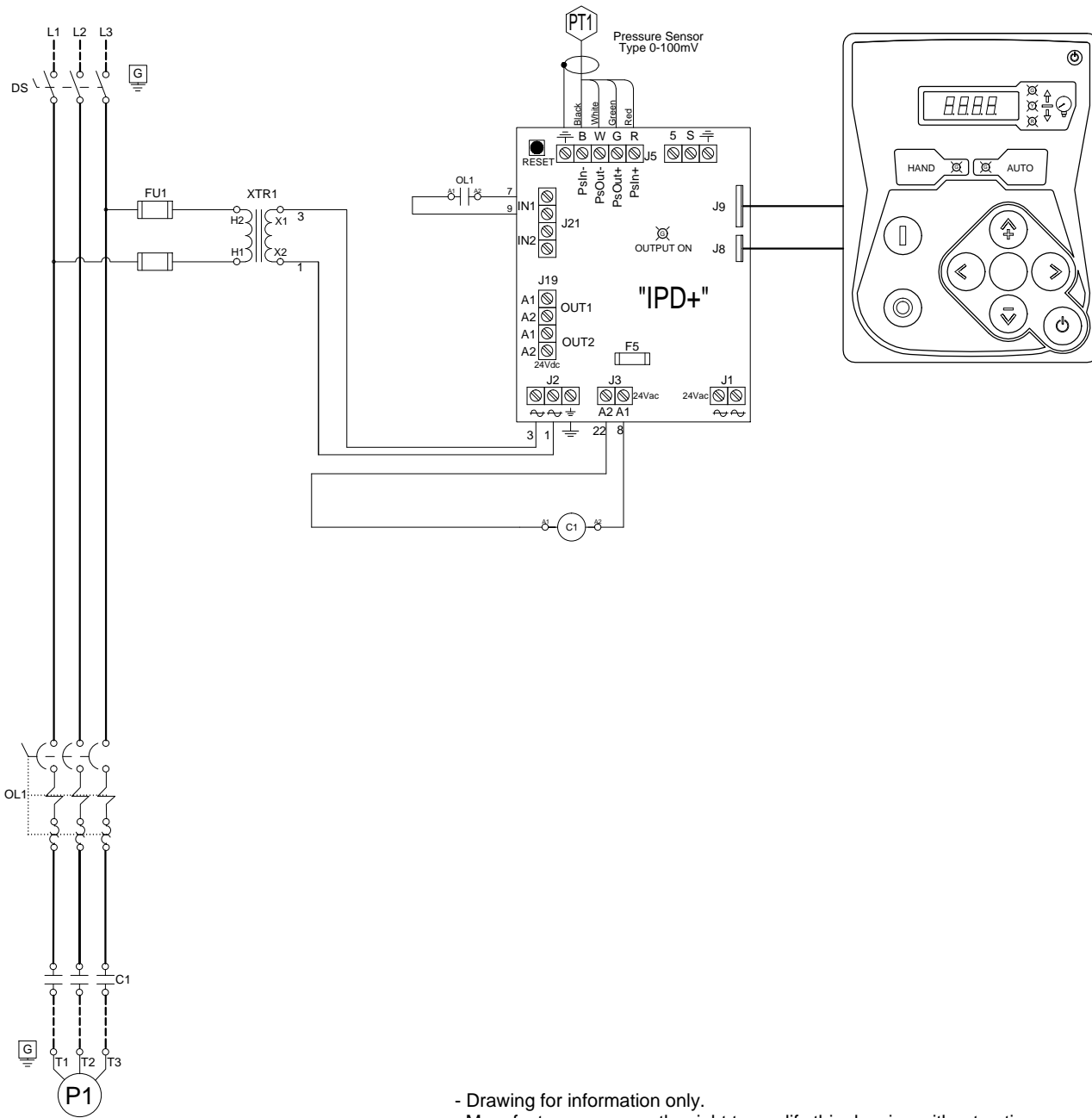

- Drawing for information only.  
 Manufacturer reserves the right to modify this drawing without notice.  
 Contact manufacturer for "As Built" drawing.

# Jockey Pump Controller

Across the Line / 3 Phase

## Line and Motor Terminal Size

Built to the latest edition of the UL 508A & CSA C22.2 No.14

### Model:JP3

PER QUOTE DRAWING No.



NYC  
Dept of Building  
Approved



REV.	DESCRIPTION	DD/MM/YY
0	First Issue	04/07/14
1	Remove Dimension Table	17/10/14
2	IPD+ R221B	23/01/14

JP3-TD500 / E

## Power Connections and Motor Connections

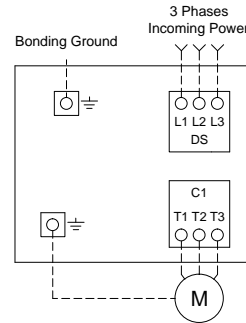

Line Terminals (L1,L2,L3,GND)

Maximum Motor Horsepower					Wire Size Copper Only	Torque	Wire Size Ground Copper Only
200-208V	220-240V	380-416V	440-480V	575-600V			
7.5HP	10HP	15HP	20HP	15HP	#14 AWG - #8 AWG	1.8 Nm	#14 AWG - #2 AWG
10HP	10HP	20HP	25HP	25HP	#12 AWG - #4 AWG	1.8 Nm	#14 AWG - #2 AWG
15HP	15HP	25HP	30HP	40HP	#4 AWG - #1/0 AWG	5.65 Nm	#6 AWG - #2 AWG

Motor Terminals (T1,T2,T3,GND)

Maximum Motor Horsepower					Wire Size Copper Only	Torque	Wire Size Ground Copper Only
200-208V	220-240V	380-416V	440-480V	575-600V			
3HP	3HP	7.5HP	7.5HP	10HP	#14 AWG - #10 AWG	1.7 Nm	#14 AWG - #2 AWG
5HP	5HP	10HP	10HP	15HP	#14 AWG - #8 AWG	1.7 Nm	#14 AWG - #2 AWG
10HP	10HP	20HP	20HP	25HP	#14 AWG - #6 AWG	2.25 Nm	#12 AWG - #2 AWG
20HP	20HP	40HP	50HP	50HP	#10 AWG - #3 AWG	5 Nm	#12 AWG - #2 AWG
25HP	30HP	50HP	60HP	60HP	#10 AWG - #2 AWG	11.3 Nm	#12 AWG - #2 AWG